



# ***INTRODUCTION TO MUSTANG Services***

***Specialized in Directional Drilling & Fishing Services***



- CONFIDENTIAL -

Jérémie CLAUDE- BD MUSTANG SERVICES

# INTRODUCTION

Welcome to MUSTANG Services, where precision meets expertise in the world of directional drilling and fishing services. We are your dedicated partner, committed to delivering innovative solutions for the most complex drilling challenges and reservoir optimization needs.

At MUSTANG Services, we understand that the energy and construction industries demand nothing less than excellence. Our unwavering focus on quality, safety, and cutting-edge technology sets us apart as a leader in the field. With a team of seasoned professionals who are passionate about pushing the boundaries of what's possible, we consistently deliver exceptional results for our clients.

# COMPANY OVERVIEW

Mustang was established in 2013, built by experienced people that specialize in the supply of Drilling services and downhole equipment for Geothermal, Oil & Gas and other similar industries.

We provide solutions combining technology, experience and expertise such as directional drilling, fishing, surveying, downhole equipment and jarring services, etc.

Mustang Services is located in Lons, near Pau, south of France, which is a strategic place for the Drilling business.

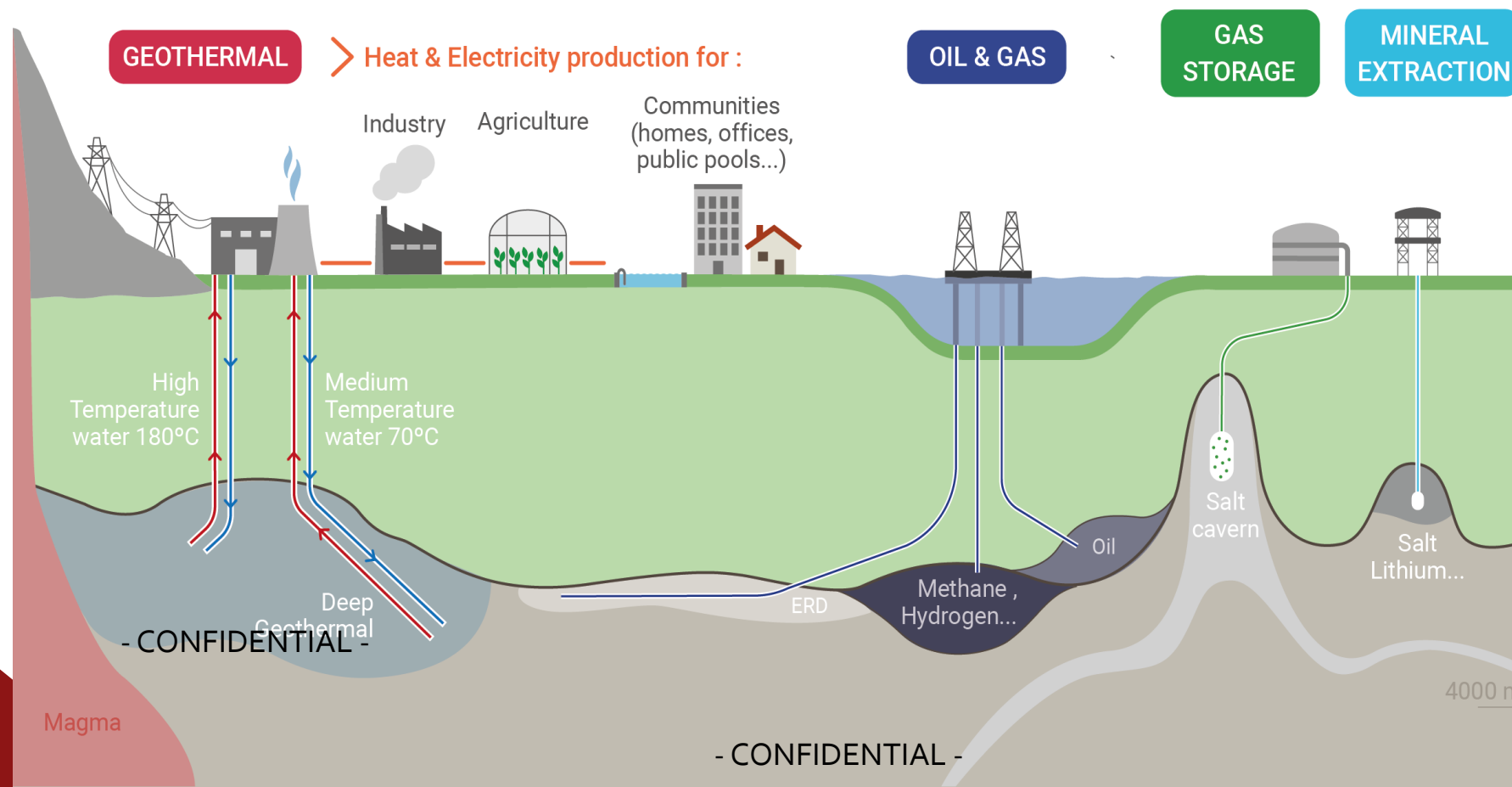

# CORE VALUES

**SAFETY:** MUSTANG Services objective is zero harm to our people, the environment, our customers and our suppliers.

**PRECISION:** Precision is at the heart of everything we do. We approach every project with a meticulous attention to detail, ensuring accuracy and efficiency in every operation.

**INNOVATION:** We embrace innovation and stay at the forefront of technological advancements in directional drilling and fishing services. Our commitment to staying ahead of the curve allows us to provide cutting-edge solutions to our clients.

**CLIENT-CENTRIC APPROACH:** Your success is our success. We take the time to understand your unique needs and tailor our services to meet and exceed your expectations. Our dedication to open communication and collaboration ensures we are always aligned with your goals.

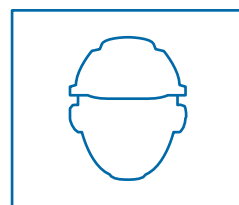

PROTECTIVE EQUIPMENT

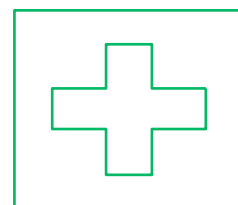

FIRST AID KIT

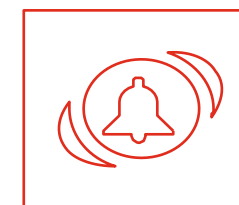

ALARM



EMERGENCY NUMBER

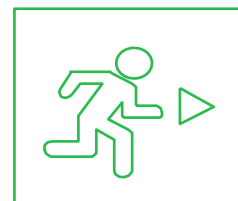

EMERGENCY EXIT

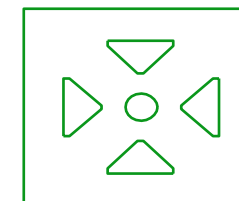

ASSEMBLY POINT

# OUR SERVICES

**DIRECTIONAL DRILLING:** We offer expert directional drilling services that enable you to access targets efficiently and maximize your well's performance. Our advanced techniques and equipment are designed to meet the most challenging drilling requirements. MUSTANG uses INNOVA Drilling Intervention directional well planning software. It optimizes performance based on cost, torque/drag or anti collision criteria. From traditional horizontal drilling to complex underbalanced applications, this advanced tool allows our experienced well planners to navigate trouble zones and keep projects on time, on target and within budget.

**FISHING SERVICES:** When unexpected downhole obstacles or equipment failures occur, our fishing services team is ready to respond quickly and effectively. We have a proven track record of retrieving lost or stuck tools, ensuring minimal downtime.

**DOWNHOLE TOOLS:** Downhole tools are the unsung heroes of drilling operations. Their durability, precision, and diverse functions are indispensable assets in the oil and gas industry, contributing to efficient drilling, data collection, and wellbore stability. As technology continues to advance, downhole tools will play an increasingly vital role in optimizing drilling processes and reducing environmental impact. We can propose variety of different equipments such: **Drilling Bits (PDCs), Underreaming, Drilling Jar, Stabilizers, Tubular, Whipstock systems etc....**

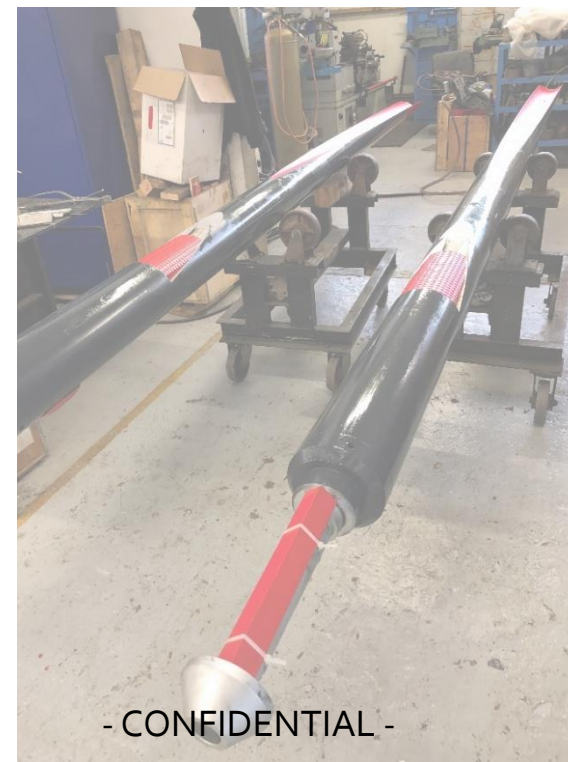
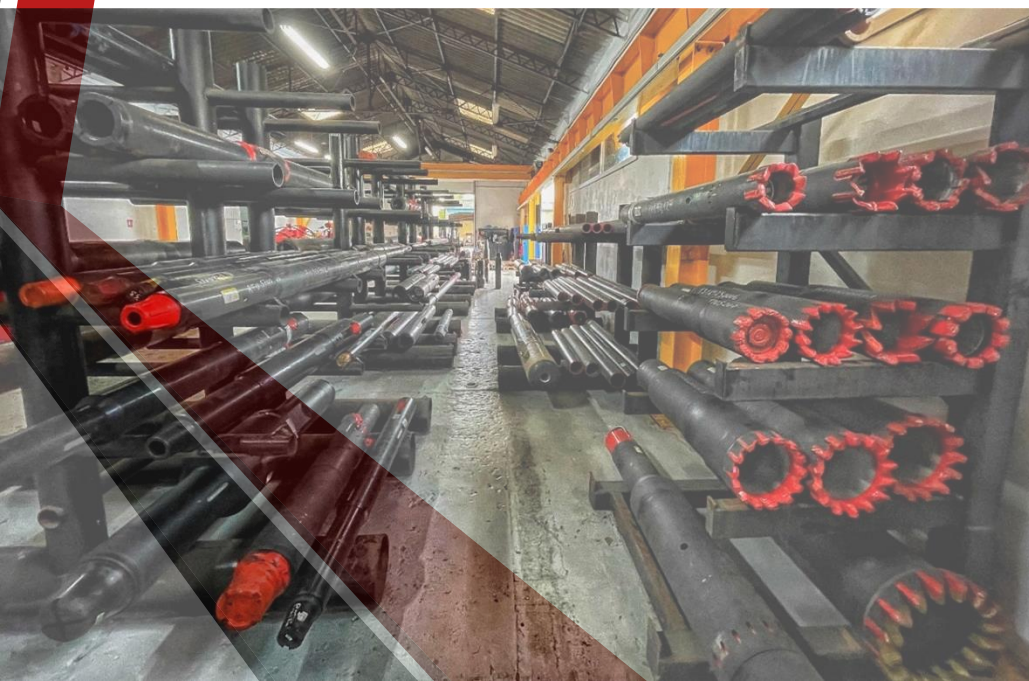

- CONFIDENTIAL -

# WHY CHOOSE MUSTANG Services

**EXPERIENCE:** With years of experience in the industry, we have successfully completed a wide range of projects, earning the trust of clients across various sectors.

**COMMITMENT TO EXCELLENCE:** Our dedication to excellence, safety, and innovation ensures that we consistently deliver superior results.

**CUSTOM SOLUTIONS:** We understand that every project is unique. Our ability to provide tailored solutions sets us apart, enabling us to address your specific challenges effectively.

**RELIABILITY:** When you choose MUSTANG Services, you're choosing a reliable partner who is always ready to go the extra mile to meet your needs and deadlines.

# CASE STUDIES - FISHING

MUSTANG Services story started with Fishing activity in 2013 and continue satisfying their customers since then. Our strength is the ability to provide dedicated tools in short notice conditions.

As we have partnership with machining company certified API 5 & 7, we build our own tools with the possibility to design and build special equipment fine tuned to specific applications.



## CUSTOMER – VERMILION ENERGY

Well	Work location	Work type
	Paris Basin / SW France	WO – P&A

## CUSTOMER – STORENGY

Well	Work location	Work type
	Paris Basin / N Ireland	Fishing / WO services / Underreaming

## CUSTOMER – EUROPEAN GAS LIMITED

Well	Work location	Work type
	E France	Fishing / Downhole tools

## CUSTOMER – DAFORA

Well	Work location	Work type
	Paris Basin	Underreaming / Downhole tools

## CUSTOMER – EDF

Well	Work location	Work type
	SW France	Down hole tool rental + well abandonment

## CUSTOMER – TARGET

Well	Work location	Work type
	SW and East France	Down hole tool rental + well abandonment + Fishing

## CUSTOMER – ADDAX

Well	Work location	Work type
	Cameroon	Side tracking

## CUSTOMER – Transatlantic Maroc

Well	Work location	Work type
	Morocco	Csg exit system & washover services

## CUSTOMER – ENI

Well	Work location	Work type
	Tunisia	Well cleaning (ventury junk basket)

## CUSTOMER – PERENCO

Well	Work location	Work type
	Turkey	Fishing tools and services
	Cameroon (offshore)	Washover, csg cut, Milling
	DRC (offshore)	Fishing tools, Fishing men, WO packers

## CUSTOMER – COFOR

Well	Work location	Work type
	Paris Basin	Downtool rental

# CASE STUDIES – DIRECTIONAL DRILLING

MUSTANG Services story continued with Directional Drilling activity which started in 2019 to offer complementary services to its partners.

MUSTANG own their proper PDMs (Positive Displacement Motor) and doubled its fleet this year (30 PDMS from 9-5/8” to 3-1/8”).

Total meters drilled from 2019: 53 300meters (26 wells)

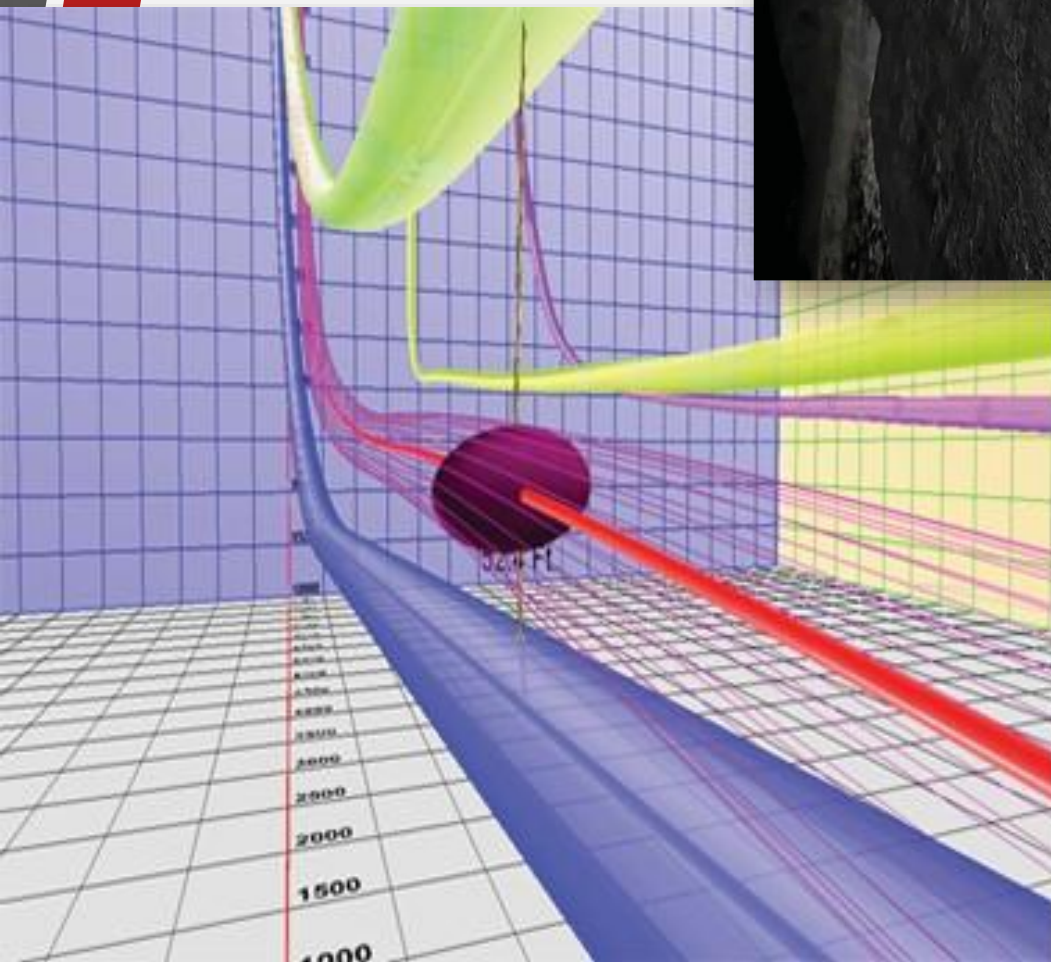

Project Owner	Well name	Date	Location
KEMONE	PA -40	July 2019	Vauvert 34
KEMONE	PA -41	August 2019	Vauvert 34
SIPPEREC	GBD-1	August 2020	Bobigny 93
SIPPEREC	GBD-2	June 2020	Bobigny 93
SIPPEREC	GBD-3	March 2020	Bobigny 93
SIPPEREC	GBD-4	December 2019	Bobigny 93
ENGIE Geomarne	GSM-1	December 2019	Chps/Marne
ENGIE Geomarne	GSM-2	January 2020	Chps/Marne
ENGIE Veligeo	GVZ-1	Sept 2020	Velizy 78
ENGIE Veligeo	GVZ-2	Nov 2020	Velizy 78
ENGIE Géorueil	GRU-1	Sept 202	Rueil-Malmaison 92
ENGIE Géorueil	GRU-2	Oct 2021	Rueil-Malmaison 92
SOMAS Maroc	C4B	August 2021	Sidi Larbi Maroc
SPPE Fublaines	MIL 102-H	December 2021	
SPPE Fublaines	MIL 202-H	December 2021	
SPPE Fublaines	IG 1-G	January 2021	
KEMONE	PA -35ST	March 2022	Vauvert 34
KEMONE	PA -42-43	Avril - Juillet 2022	Vauvert 34
MALM	Montagny-2 & Montagny-2ST		
ENERGIE		Nov 2022 – Jan 2023	
SEER	GGR-4&5	Nov 2022 – Mars 2023	
Massé	F4	Jan 2023 – Fév 2023	
Coriance	GCHM-4&5	Mars 2023 – Mai 2023	
IPC	MRS3ST	March 2023 – April 2023	
UNIGEO	GLPSG-1/2/3/4	June 2023 – December 2023	
SMIREC	GSD-1&2	August 2023 – October 2023	



# CASE STUDIES - WHIPSTOCKS

Mechanical retrievable Whipstocks (7-5/8”) + Single trip window mills (and their backups) provided for several offshore & onshore operations since 2021.

## CUSTOMER – PERENCO CAMEROON

### Well

INM-06ST

### Work location

Offshore Cameroon

### Work type

Well ST with Whipstock

## CUSTOMER – PERENCO DRC

### Well

GCO-5ST

### Work location

Offshore DRC

### Work type

Fishing tools - Fishing men- ST with Whipstock

LIB-11-12-13-14ST2

Offshore DRC

Fishing tools - Fishing men- ST with Whipstock

MIB-6ST-18-14ST2

Offshore DRC

Fishing tools - Fishing men- ST with Whipstock

MOT2-MOT4-MOT15ST

Offshore DRC

Fishing tools - Fishing men- ST with Whipstock

## CUSTOMER – KEM ONE

### Well

PA28-ST

### Work location

Onshore France

### Work type

Well ST with Whipstock

PA29-ST

Onshore France

Well ST with Whipstock

PA35-ST

Onshore France

Well ST with Whipstock

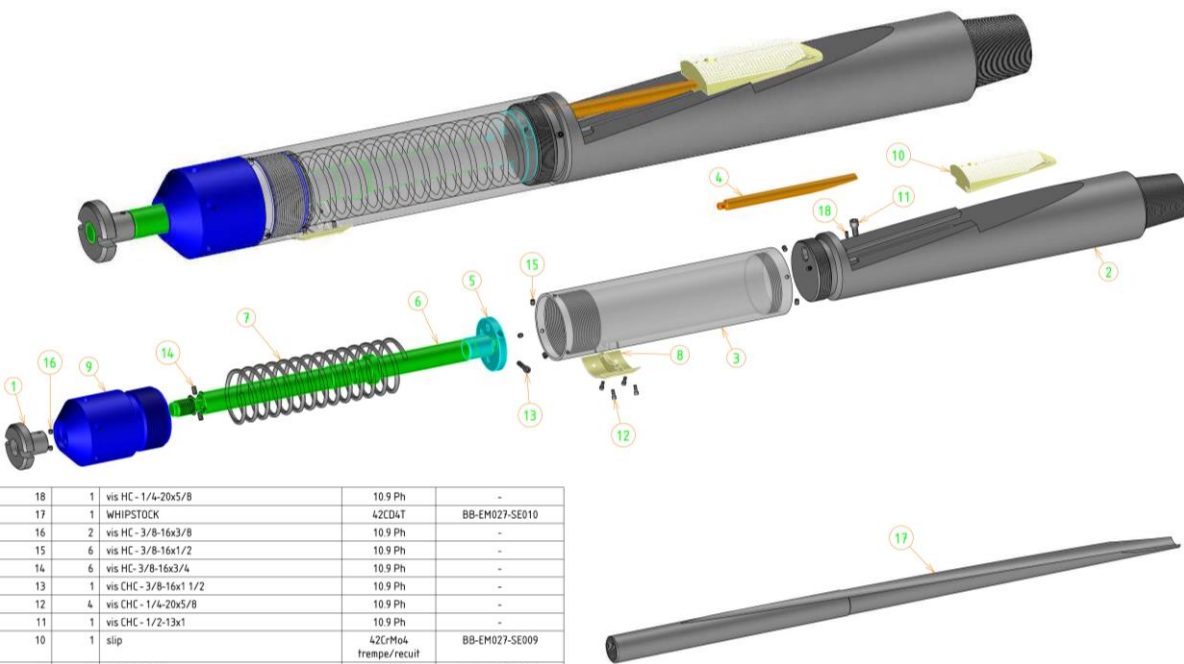

# PROJECTS ON GOING / INNOVATION

To offer complete drilling solution package, MUSTANG works to develop multiples tools / services such:

- **Data recorder for downhole logging:** goal is to collect downhole data and compute them to make your operations more efficient
- **Reamer stab to provide smoother wellbore:** aim is to smooth POOH, prevent stuck pipe situation, eliminate wiper trips and ensure the smooth deployment of casing
- **PDC bit offer (repair):** our team can build on its experienced team to provide PDC bit repair services. A PDC bit repair consist of cutter rotation or replacement, body rebuilding or upper section replacement. Optimized drill bit fleet (1<sup>st</sup> / back-up), affordable bits refurbished as new with latest cutter tech, several repair level make this service a real added value for the customer





# Q&A?

**THANKS FOR YOUR  
ATTENTION AND YOUR  
DEDICATED TIME**

